

An Essential Health Care Patent Pool

XIV International AIDS Conference

James Love

Consumer Project on Technology

<http://www.cptech.org>

July 8, 2002

Barcelona, Spain

There are many barriers to treatment

- Inadequate funding and infrastructure
- Lack of education
- Insufficient R&D on vaccines, new drugs, tests, delivery mechanisms
- High prices



High prices are a barrier to access

- Lack of competition
 - Regulatory barriers
 - Patent and other intellectual property barriers
- Inefficient distribution systems
- Inefficient procurement policy

The changes in prices for Fluconazole in Thailand, following the introduction of competition in 1998, made treatment affordable

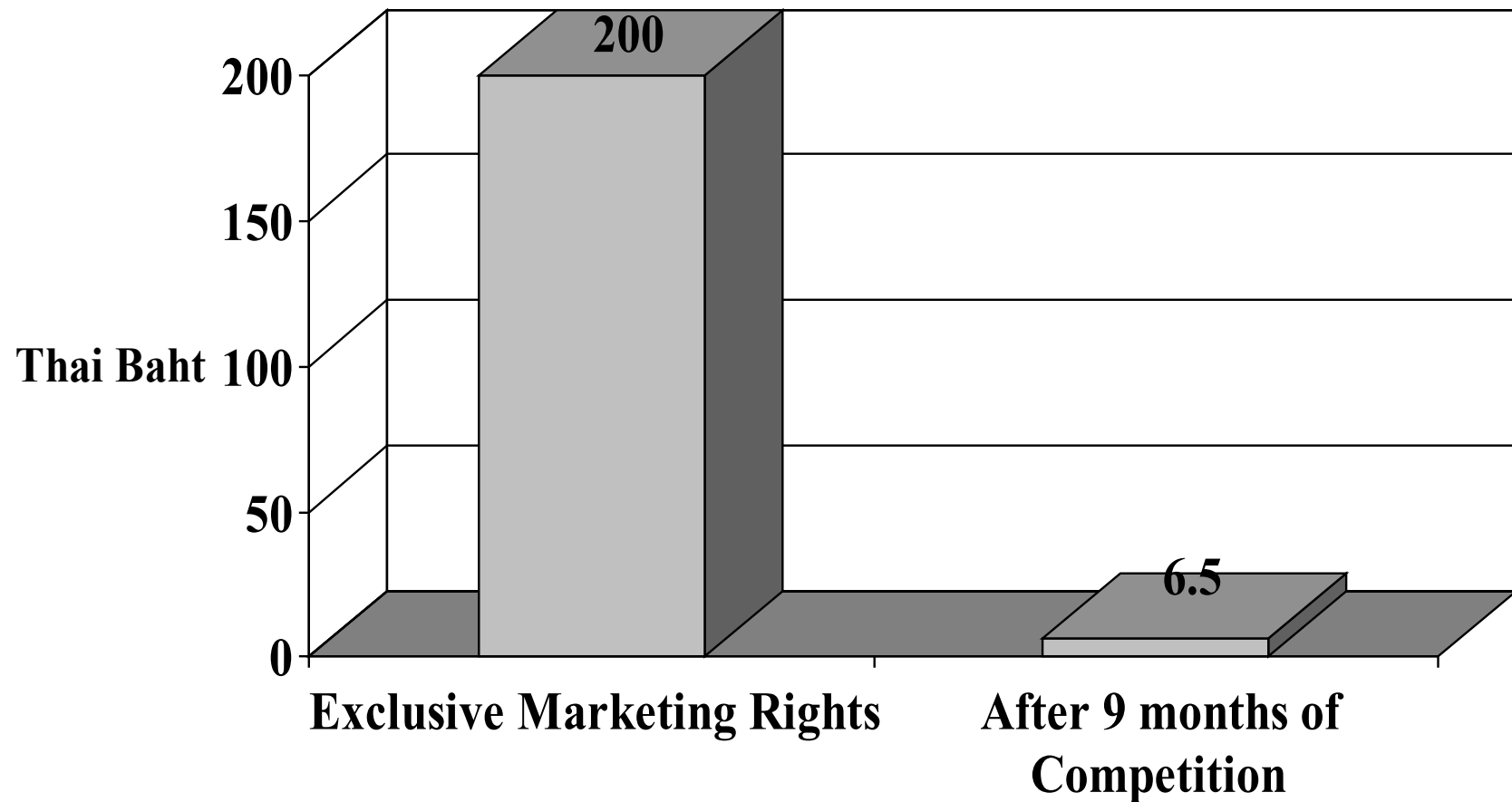

Brazil's decision to purchase generic HIV drugs transformed the global market

- Brazil changed its patent law in 1996, but could still buy generic products that were invented earlier
- In the beginning, price savings were modest.
- Over time, competition brought more benefits.
- Brazil's decision to buy generic drugs was key to its ability to offer universal treatment
- Other countries benefited from the Brazil decision to purchase generic products

Price of raw materials for 3TC

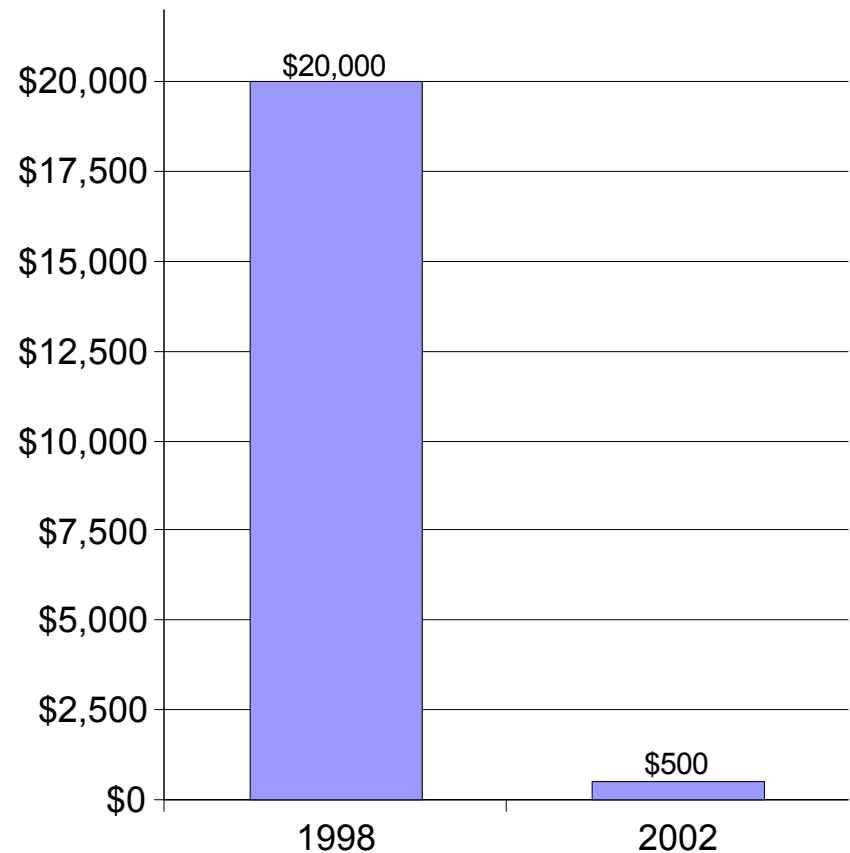

Patents are important, and do create
barriers

Seven Antiretroviral products are widely Patented in Africa

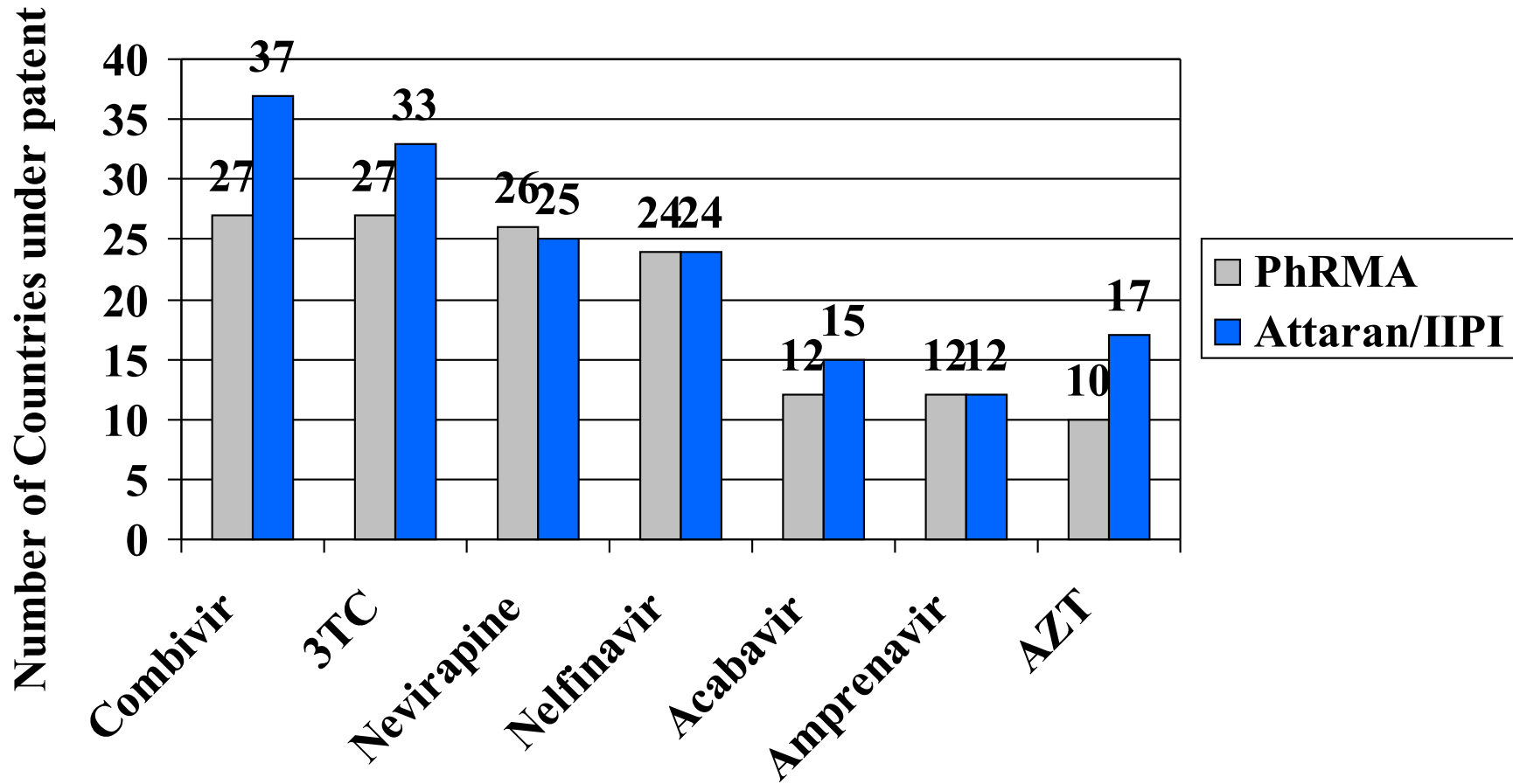

Fixed dose combinations may reduce compliance problems

- Patents are often a barrier to development of combination products

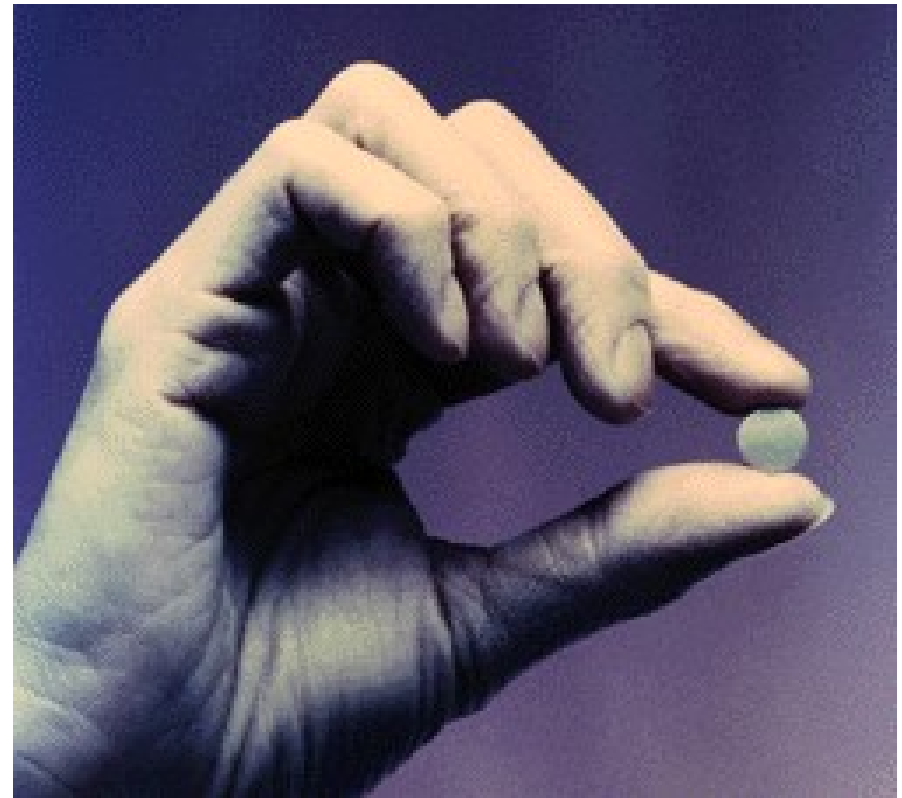

Litigation can be expensive and time consuming

- Developing countries are struggling to overcome patent barriers, in part because of the high costs of litigation.



Proposal for a non-voluntary patent pool for essential health care inventions

- Modeled after the US government effort in 1917 to create a pool for essential aircraft patents

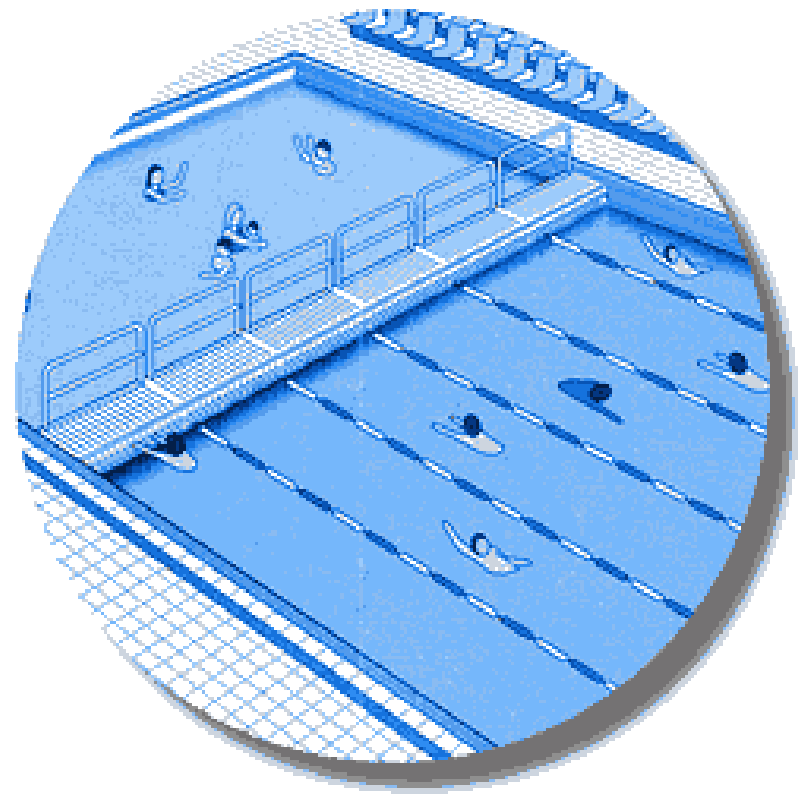

War and Patent Story

In 1903, Wilbur and Orville Wright
flew the first airplane

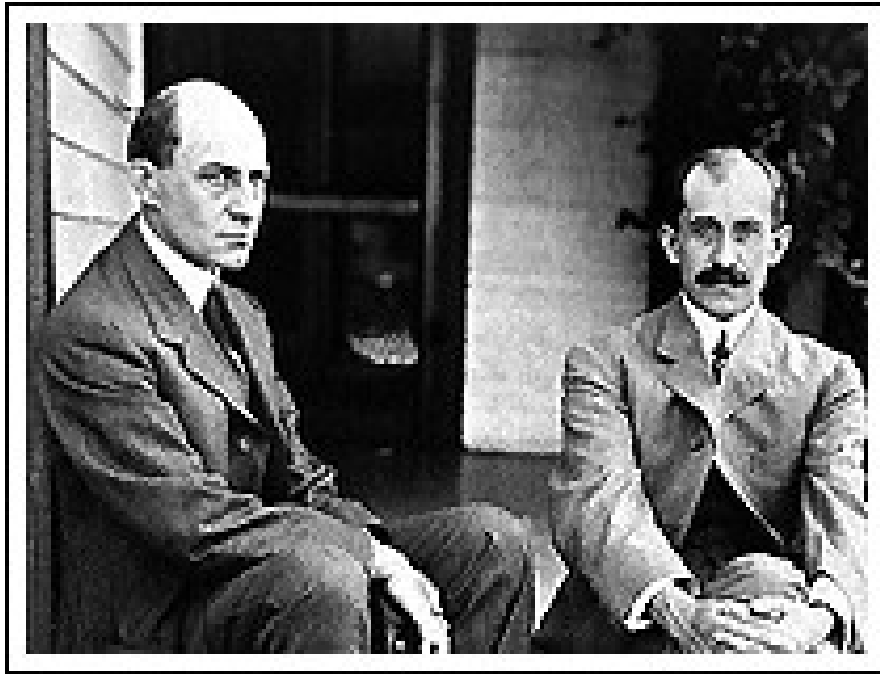

Wilbur and Orville Wright

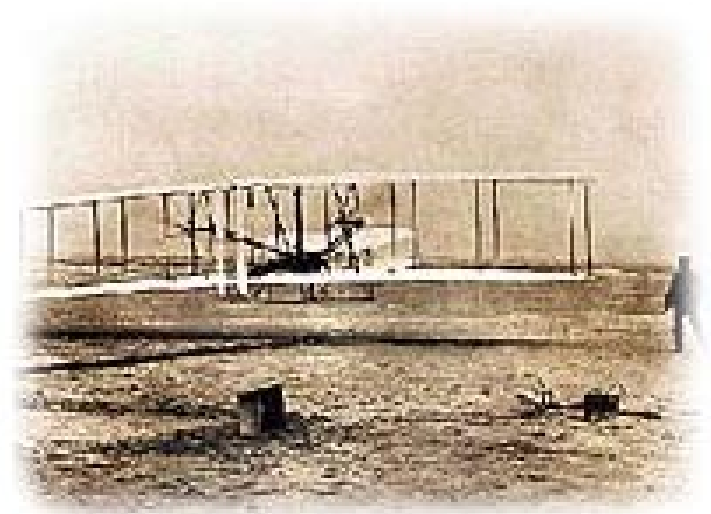

In 1906 they received US patent No. 821,393 for a flying machine

WITNESSES:
William F. Raven.
George Miller.

FIG. 1.

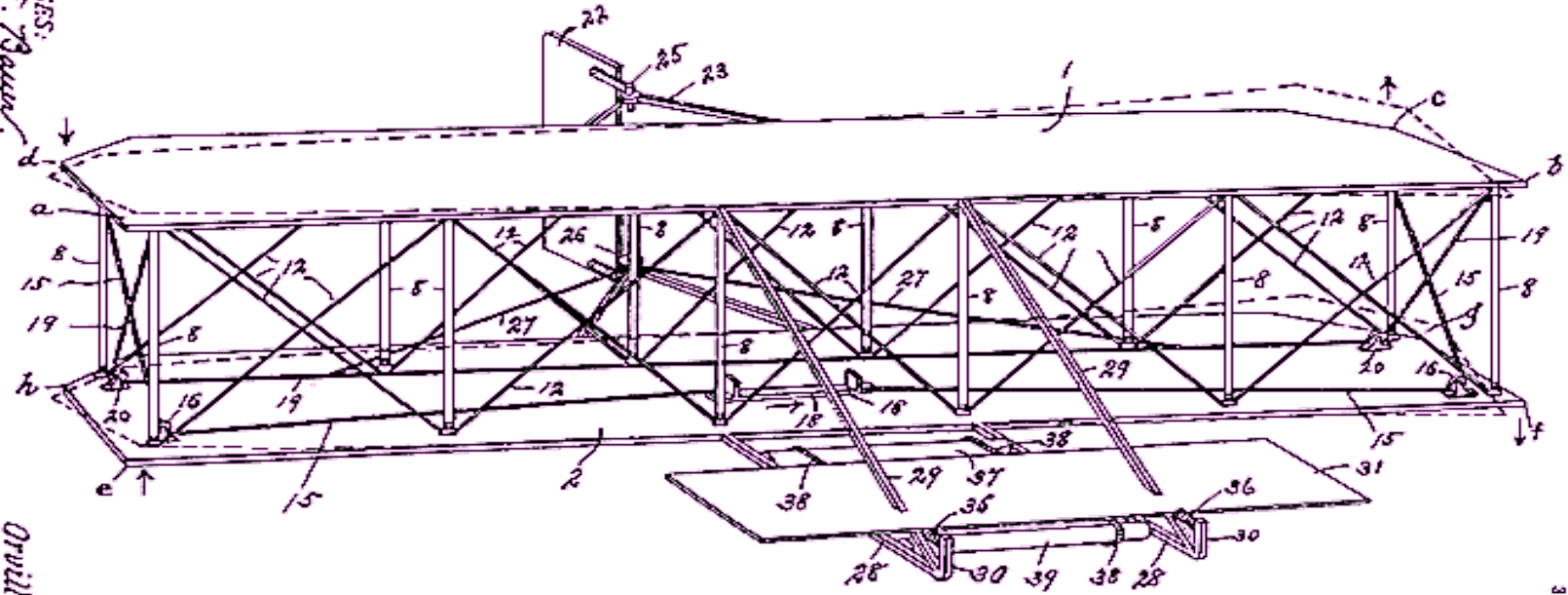

INVENTORS.
Orville Wright.
Wilbur Wright.
BY
W. S. Paulsen,
ATTORNEY.

Glenn Curtiss and others improved upon the Wright Plane

- In 1909 Curtiss won the James Gordon Bennett Cup at Reims, France.
- Backed by Alexander Bell and others, the Curtiss companies obtained additional patents

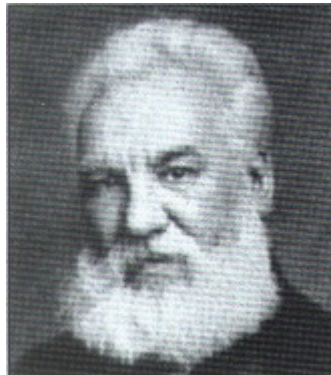

The Wright Brothers sued the Curtiss companies over patent infringement and won

- After several years of litigation, in 1913, the Federal Circuit Court of Appeals ordered Curtiss to cease making airplanes
- Henry Ford had earlier fought patent litigation that would have destroyed his business, and he helped Curtiss obtain a stay of the verdict.
- Even then, patent litigation was very expensive.

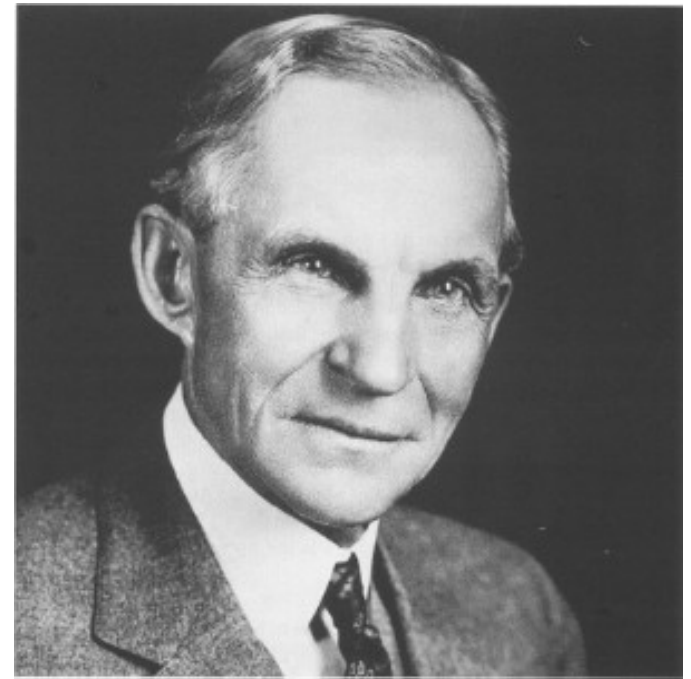

In 1914, war broke out in Europe.



Aircraft became important to national security

- It was impossible to manufacture aircraft in the USA without the Wright and Curtiss patents



The Navy asked FDR to study the aircraft patent problem



- A National Advisory Committee for Aeronautics was created pursuant to an act of Congress “to consider and advise the President and the departments on aeronautical problems and to consider and devise some plan to remedy the existing difficulties” in the manufacture of aircraft.

On January 17, 1917, the Navy said patent litigation had retarded the development of the US aircraft industry

- “the development of the aircraft industry in the United States was seriously retarded by the existence of a chaotic situation concerning the validity and ownership of important aeronautical patents. This situation was one of great concern to the Government of the United States. . .
- **“various companies were threatening all other airplane and seaplane manufacturing companies with suits for infringements of patents, resulting in a general demoralization of the entire trade;** that it was difficult for the Government to obtain fulfillment of orders because some companies would not expend any money on their plants for fear that suits brought against them would force them out of business; that to protect themselves in case they were **forced to pay large license fees** the companies had greatly increased the sales prices of their products to the Government .
- Manufacturers Aircraft Association, Inc., v. the United States, 77 Ct. Cl. 481

The government recommended the creation a pool for essential aircraft patents

- **March 23, 1917**

- A joint meeting of the Committee, the War and the Navy Departments and the aeronautical industry was held to discuss "various means by which the basic airplane patents could be acquired by the Government for the development of the industry" noting "just recognition will be made to the owners of the more important or basic patents in the form of reasonable royalties to be paid by the purchasers of planes whether for military or civil use."

- **March 24, 1917**

- The patent committee of the National Advisory Committee rendered a report recommending "the formation of the Aircraft Manufacturers Association among all aircraft manufacturers to manage a patent pool."

On March 24, 1917,

the US Congress passed a law to enable the Secretary of War and the Secretary of the Navy to secure by purchase, condemnation, donation, or otherwise such basic patent or patents as they may consider necessary to the manufacture and development of aircraft in the United States for governmental and civil purposes.'

On April 6, 1917, the United States
Entered the War

The Manufacturers Aircraft Association patent pool was formally created in July

– June 14, 1917

- the executive committee of the National Advisory Committee for Aeronautics "authorized the patent committee to take such steps as appeared necessary to effect a solution of the patent question and recommended that royalties to be paid by the Aircraft Manufacturers Association" to the "Wright and Curtiss Companies, who owned the principal airplane patents, be limited to two million dollars each."

– July 10, 1917

- a meeting was held with competitive airplane manufacturers and the Wright and Curtiss patent owners.

– July 16, 1917

- The Manufacturers Aircraft Association was incorporated in New York

– July 24, 1917

- The first MAA meeting was held and the patent pool was formally created.

The federal government forced the patent owners to accept lower royalties

- Prior to the creation of the patent pool, the Wright Brothers were asking \$1,000 per aircraft as a royalty (about 5 percent of the cost of a plane then) for a single patent. The federal government forced patent owners to accept a \$200 flat fee for each airplane that was manufactured, and later lowered this to \$100 per plane. The royalties were divided 67.5 percent to the Wright Brothers, and 20 percent to the Curtiss-Burgess company, with the remainder used to support the MAA. The royalties to both the Wright and Curtiss patent owners were reduced once they accumulated \$2 million in royalty payments, to \$25 per airplane.
- The changes in the royalties were forced on the patent owners, under the threat of the government taking the patents.

Postscript on “war” story

- Patents weren't the only problem in fighting a war.
 - To fight a war you needed funding, infrastructure, training, political will, strategy and lots of other things.
- But the government still fixed the patent problem, and did so in a hurry.

What about the “war” on HIV?



The WHO has a list for essential drugs

- The list of essential drugs is based upon cost effectiveness
- Many patented drugs would be on the list if the prices were lower

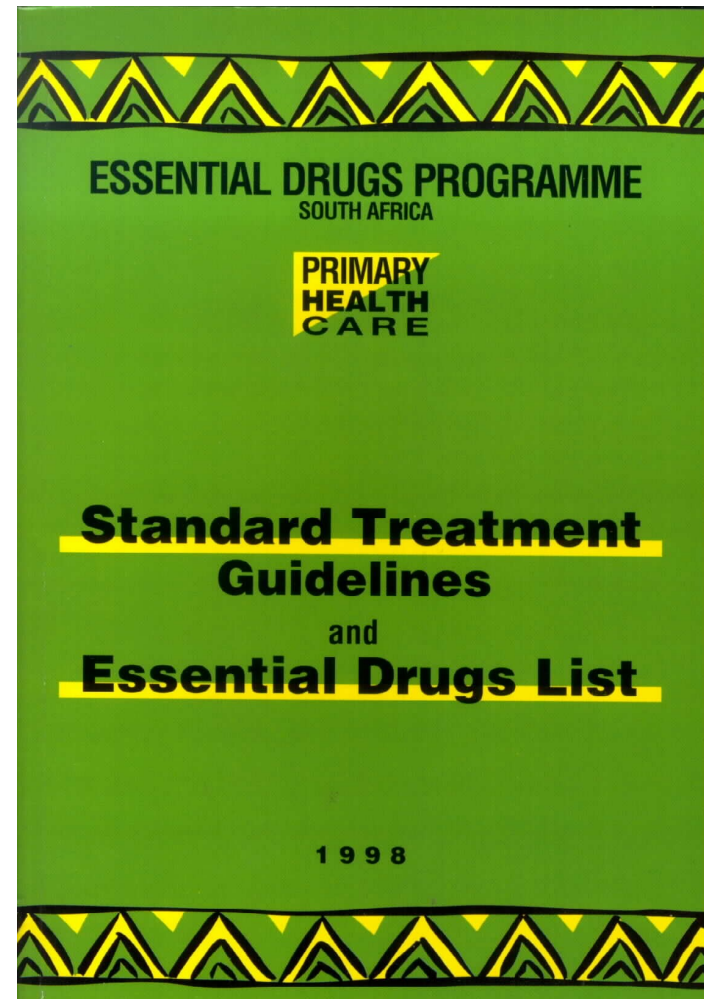

Proposal

- Create a non-voluntary patent pool for inventions that address essential public health needs

How would it work?

1. Anyone could petition the government or managers of the patent pool to include a particular particular health care invention.
2. The government or the managers of the pool would determine if the inclusion of the invention into the patent pool were necessary to promote competition for the supply for essential public health goods. This would be done on the basis of expert advice on the degree to which the invention is not presently available to those who need it.
3. Anyone would have the right to use the patents in the pool to manufacture essential health care products.
4. A person who used the patents would pay a single royalty to the patent pool. The amount of that royalty would be determined by the fund, based upon transparent royalty guidelines and expert opinion.
5. The patent owners would divide the royalty payments according to advice of experts, or through arbitration.

For more information

<http://www.cptech.org>

Subscribe to ip-health

[http://lists.essential.org/mailman/listinfo/
ip-health](http://lists.essential.org/mailman/listinfo/ip-health)